

1967-1981 Chevy Camaro Suspension



DSE HYDROFORMED SUB-FRAME

Detroit Speed's all new front sub-frame is a bolt-in replacement for the original 1967-69 and 1970-81 sub-frame. It improves the handling and ride quality by utilizing DSE's unique suspension geometry. DSE features OEM style hydroformed frame rails and stamped crossmembers for strength and stiffness and precise quality. *The sub-frame comes complete with:* tubular upper and lower control arms, coil-over shocks and springs, power rack and pinion steering, splined sway bar, C6 Corvette uprights and mounting for SBC, BBC, LS1, LS2, and LS7 engines. Powder coating optional.

032001	1967-69, 450 lb/in SBC, LS	\$6,900.00
032002	1967-69, 525 lb/in BBC, Pontiac.	\$6,900.00
032011	1970-81, 450 lb/in SBC, LS	\$7,200.00
032012	1970-81, 525 lb/in BBC, Pontiac.	\$7,200.00

DSE QUADRA-LINK™ REAR SUSPENSION

Detroit Speed's 4-link geometry is optimized to achieve the best possible ride, handling and improved anti-squat control. The long upper links provide great pinion and u-joint angle control and an adjustable panhard rod provides precise and effective rear axle lateral location during hard cornering. The new DSE "Swivel-Link™" allows the suspension to fully articulate without binding. Tuned high durometer rubber bushings are used in place of noisy heim- joints or urethane bushings. A rear upper shock crossmember strengthens the rear body and frame section. Use DSE Deep Tubs or stock tubs (please specify). *Kit includes:* Detroit Tuned' Coil-over shocks/springs and black powder coated 4-bars, brackets, panhard bar, shock mount/crossmember. Note: requires a 3" axle tube. Ford 9" housings and Chevy 12 bolt housings are available pre-welded.

041703	1967-1969 Camaro	\$2,400.00
041711	1970-81 Camaro	\$2,600.00

Please Call Rear axle housing with brackets **\$1,110.00**



DSE QUADRA-LINK™ REAR SWAY BAR

Fine tune your handling with this adjustable rear sway bar for DSE rear Quadra-Link suspensions. Includes bolt-on brackets. 1.00 or 1.125" diameter.

042203	1967-69 Camaro rear sway bar kit	\$325.00
042207	1970-81 Camaro rear sway bar kit	\$325.00

HEIDTS CAMARO PRO-G SUB-FRAME ASSEMBLY

This new 1968-74 bolt-on front sub-frame uses Heidt's new Pro-G™ suspension package for unbelievable cornering and overall handling. Simply unbolt and remove your front sheet metal, engine/trans, old sub-frame, then slide in the new complete sub-frame. All the sheet metal bolts back in place *There are many control arm, sway bar, shock and brake upgrades. Please call.*

The base kit includes: Pro-G sub-frame, Pro-G 2" dropped spindles, transmission x-member, tubular upper and lower arms, power rack and pinion steering, 11" Wilwood brakes with black calipers, billet coil-overs, single adjustable shocks with chrome springs,

CF-101	1967-69 Camaro.	\$4,450.00
CF-201	1970-81 Camaro.	\$4,450.00
SB-110	1" front sway bar	\$229.00
SB-401	1.25" Splined front sway bar	\$549.00





DSE REAR MINI-TUB KITS

Rear Mini-Tub kit moves the leaf springs in for more tire clearance. The kit includes: DSE deep tubs, rear upper shock crossmember, rear upper shock mounts, offset shackles, rear leaf springs, adjustable leaf spring pads, lower shock plates, U-bolts, mini-tub video, templates and detailed, installation instructions. You will need special DSE shocks and a narrowed fuel tank. 1970-81 kits also include special spring pockets and frame rail filler panels

041203	1967 Camaro, 2" drop	\$1,730.00
041204	1967 Camaro, 3" drop	\$1,730.00
041205	1968-69 Camaro, 2" drop	\$1,730.00
041206	1968-69 Camaro, 3" drop	\$1,730.00
041222	1967 Camaro, 2" drop	\$1,730.00
041205	1967 Camaro, 3" drop	\$1,730.00



DSE CAMARO SUB-FRAME CONNECTORS

Detroit Speed weld-in sub-frame connectors are fabricated from 2" x 3" x 0.120" wall rectangular steel tubing. Laser cut brackets attach to the rear of the sub-frame and rear frame rails. These sub-frame connectors fit tight to the floor and are barely visible from outside the car

010101	1967-69 Camaro	\$190.00
010103	1970-81 Camaro	\$190.00



HEIDTS 1968-72 CAMARO SUB-FRAME CONNECTORS

Completely bolt-on, with no cutting or floor modifications. Sub-frame connectors tie the front sub-frame into the rear spring mounts.

CF-107	1967-69 Camaro/Firebird	\$215.00
CF-110	1967-69 Camaro/Firebird convertible	\$215.00
CF-202	1970-82 Camaro/Firebird with factory suspension	\$215.00
RC-122	1970-82 Camaro/Firebird Heidt's Pro-G suspension sub-frame connectors	\$215.00

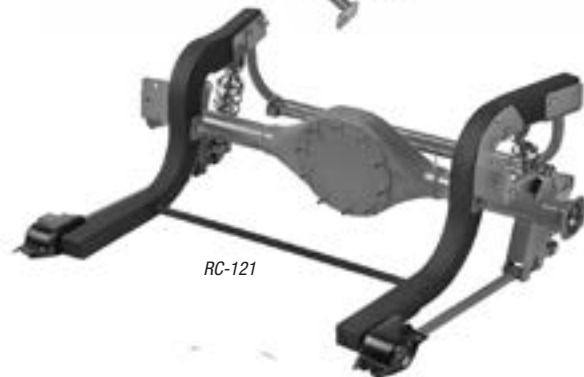

HEIDTS 1967-81 CAMARO REAR 4-LINK

Bolt-on maximum performance for your Camaro or Firebird. **The base kit includes:** chassis and axle brackets, adjustable links, full upper coil-over crossmember, panhard bar, adjustable HEIDTS coil-overs and all hardware. Completely bolt-on, with no cutting or floor modifications. Adjustable 4-link mounts allow suspension tuning. There are many brake, stainless steel and rear end housing upgrades. Please call. The driveshaft loop is optional and requires the sub-frame connectors.

RC-101	1967-69 Camaro/Firebird	\$1,500.00
RC-121	1970-81 Camaro/Firebird	\$1,500.00
RC-037	1967-69 driveshaft hoop	\$95.00
RC-125	1970-81 driveshaft hoop	\$95.00
SB-120	1967-69 rear sway bar	\$279.00
SB-170	1970-81 rear sway bar	\$279.00



HEIDTS PRO-G INDEPENDENT REAR SUSPENSION KIT FOR 1967 TO 73 CAMARO

The Heidts PRO-G IRS system will totally transform your Camaro. This is a bolt-in high-horsepower unit and includes sub-frame connectors that stiffen the body and locate the suspension. Included is a 9" Aluminum housing, posi-traction iron 3rd member, your choice of ratios, Wilwood 10.5" disc brakes, CV joint axles, billet adjustable coil-overs, crossmember and brackets, front pinion support and more. Track is 56.5". A parking brake kit is available. Please call.

IRC-101	1967-69 Camaro- plain rotors	\$9,195.00
IRC-101-S	with drilled and slotted rotors	\$9,495.00
IRC-102	1970-73 Camaro- plain rotors	\$9,195.00
IRC-102-S	with drilled and slotted rotors	\$9,495.00

Call 402.886.2275 or click: www.heinzmanstreetrods.com

1967-1981 Chevy Camaro Suspension

1967-1981 Chevy Camaro Suspension



DSE DEEP WHEEL TUBS

These three inches wider wheel tubs will accept monster tires. They are stamped from 18 gauge steel in the USA, fit perfect, look stock and save a ton of work. The Deep Tub's can be purchased as a pair or as part of the complete mini-tub kit:

- 040401 1967-69 Camaro deep tubs pair \$399.00
- 040403 1970-81 Camaro deep tubs pair \$475.00



DSE CAMARO SPEED KITS

Detroit Speed's front suspension kits combine individual components into a system designed for your vehicle at three different levels. The *DSE Speed Kit 1* provides the ease of bolt-on components to improve your Nova's handling. The *Speed Kit 2* improves the handling performance to the next level and offers ride height adjustment. The *Speed Kit 3* is the most advanced handling system you can buy for use with the stock sub-frame. It gives you the ultimate steering performance of today's modern performance cars.

Speed Kit 1: tubular upper control arms, tubular lower control arms, stock spring pocket, Koni classic front shocks, front 2" drop springs, front sway bar

Speed Kit 2: kit #1 with coil-over conversion kit, Koni aluminum body coil-over shocks, coil-over springs, and fixture for positioning

Speed Kit 3: kit 2 plus DSE 600 steering gear with rag joint and pitman arm, DSE tie rod adjusters, inner and outer tie rod ends and idler arm.

- 031301 1967-69 Speed kit 1 (specify SB or BB) ... \$2,045.00
- 031302 1967-69 Speed kit 2 (specify SB or BB) ... \$2,653.00
- 031303 1967-69 Speed kit 3 (specify SB or BB) ... \$3,625.00
- 031307 1970-81 Speed kit 1 (specify SB or BB) ... \$2,110.00



HEIDTS TUBULAR UPPER & LOWER CONTROL ARMS

Beef up your suspension and tighten your handling with Heidts tubular control arms. Both upper and lower arms are available in stock width or narrowed 1" per side. They come beautifully black powder coated, and are fitted with high performance urethane bushings and factory ball joints, ready to install in your chassis. The narrowed arms allow you to run wider tires, without rubbing the fenders. Lower arms are also available for coil-over shocks

- CA-301 68-72 Nova upper control arms. \$450.00
- CA-301-N 68-72 Nova upper control arms-narrowed. . \$450.00
- CA-311 68-72 Nova lower control arms \$625.00
- CA-311-N 68-72 Nova lower control arms-narrowed \$625.00
- CA-311-M 68-72 Nova coil-over lower control arms . \$625.00
- CA-311-NM 68-72 Nova coil-over lower control arms . \$625.00
- 68-72 Nova coil-over lower control arms -narrowed \$625.00
- CC-064 Narrowed Tie Rod Ends for Narrowed Control Arms each \$19.95

HEIDTS TALL 2" DROPPED STEEL SPINDLE

The upper ball joint is raised 1-1/2" over the factory design to yield a better camber change during suspension movement. This corrects the excessive camber change of the original design . These spindles are steel, the strongest ones in the industry.

- SP-110 2" Dropped spindles pair \$340.00

QA1 COIL OVERS

Billet coil-over shocks have fully adjustable dampening. Silver powder coated full length progressive springs assure full travel and smooth ride with spring rates for small block and big block. They also fit stock lower arms using adapter kit CS-020.

- GS401 Coil-over shocks pr \$529.00
- 450# 10" Coil-over springs, smal block. . . included
- 550# 10" Coil-over springs, big block . . . included

Springs are available in 300-700 lb increments



SWAY BAR FOR STOCK NOVA SUB-FRAME

1-1/8" diameter stiffer sway bar for the stock sub-frame. Bolt-on.

- SB-069 1968-72 Nova, 67-69 Camaro sway bar . . \$238.00

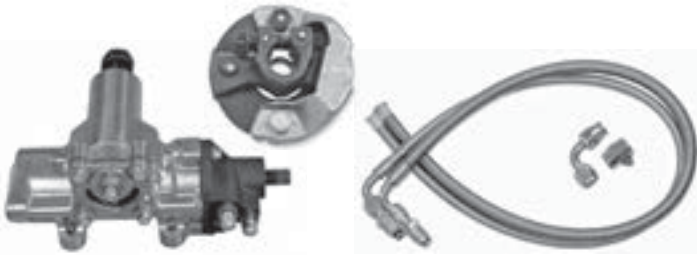

GM-DELPHI 600 POWER STEERING GEAR

This all new steering gear replaces the common GM 800 series power steering gear used from 1964 to 1992. It uses low friction gear design and precision rack and pinion valve technology for increased steering feel. Quick ratio 12.7:1 and 6 lbs lighter than stock. Original power pitman arm may be used. A 3/4 x 30 spline rag joint and new o-ring power steering hoses are needed

- 090204 1967-1991 Camaro, ready to paint \$595.00
- 090204C 1967-1991 Camaro, Ceramic coated \$780.00
- 090205 Rag Joint, connects to stock column \$99.00
- 091202 Steering Hose Kits for 600 Gear Box. \$150.00



DSE ALUMINUM POWER STEERING PUMP

This pump is compatible with any power steering box or rack. These are new, not remanufactured pumps. They are available with a special flow control valve for Mustang II racks. Integral black plastic reservoir is included. Available polished, in cast iron, or without the reservoir for remote fill.

- 090901 Aluminum power steering pump w/res . . . \$240.00
- 090301 Aluminum power steering pump w/o res . . \$240.00
- 091001 Cast iron power steering pump w/res \$175.00
- 090801 6" V-belt PS pulley \$68.00

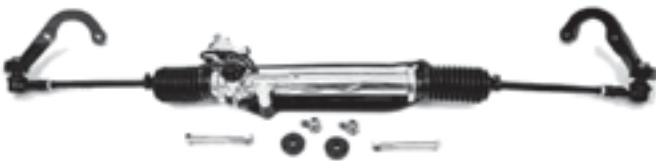

UNI-STEER RACK & PINION CONVERSION KIT

Uni-steer's Camaro rack and pinion will greatly improve handling and steering effort, while providing modern road feel. This kit is specifically designed for the Camaro's suspension, so there is no bump steer. Best of all, these are bolt-on kits, so no chassis modifications are necessary. Kit includes custom made rack & pinion mounted to bolt-on bracket, new bolt on steering arms (power rack kit only), all fittings, hardware, and complete installation instruction guide. Chrome racks are also available. Power racks work with the original PS pump.

- 8010540-01 1967-69 Camaro power rack & pinion kit . . \$890.00
- 8000770-01 1967-69 Camaro manual rack & pinion kit . \$646.92



T-56 TRANSMISSION CROSSMEMBER

This crossmember is specifically designed to mount a T-56 six-speed manual transmission in the proper location and add significant torsional stiffness to your car. The bolt in lower mount, allows easy removal of the transmission when required.

- 011201 1967-91 Camaro \$725.00
- 011202 Transmission mount \$45.00

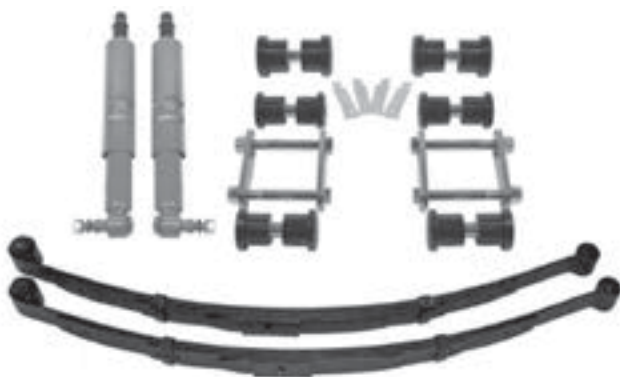

DSE REAR LEAF SPRING SUSPENSION KIT

This kit works great with any of the DSE front suspension systems. DSE leaf springs improve handling due to the increased spring rate and are available in either a 2 or 3" drop to lower ride height.

Kit includes: DSE rear leaf springs (2 or 3" drop), heavy duty shackle kit, Koni classic rear shocks. Specify 2 or 3" drop

- 041601 1967-69 Camaro multi-leaf spring \$760.00
- 041635 1970-81 Camaro multi-leaf spring \$760.00



DSE STAINLESS STEEL HEADERS

These DSE headers are designed and engineered for LS engines in the 1967-1969 Camaro/Firebird and 1968-74 Nova DSE Hydro-formed Subframe. The DSE Stainless Steel LS Headers feature a 1-7/8" primary tube diameter with 4-way merge collectors featuring V-Band clamps. Each header features a O2 sensor bung in the collector.

- 1967-1969 Camaro, 1968-1974 Nova . . . \$2230.00

Call 402.886.2275 or click: www.heinzmanstreetrods.com

1967-1981 Chevy Camaro Suspension



62-74 CAMARO DISC KITS FOR DRUM BRAKE SPINDLES

This ECI brake kit bolts to the stock drum brake spindle with no machine work or spindle modifications, and does not move the wheels out. The kit uses stock big piston GM calipers and 11 inch GM rotors on special ECI billet hubs. Kit includes rotors, calipers with pads, bearings, seals, caliper mounting brackets, aluminum hubs and dust covers.

EC-723ACK 1967-69 Camaro \$575.00

Add \$100.00 for 13 in. rotors

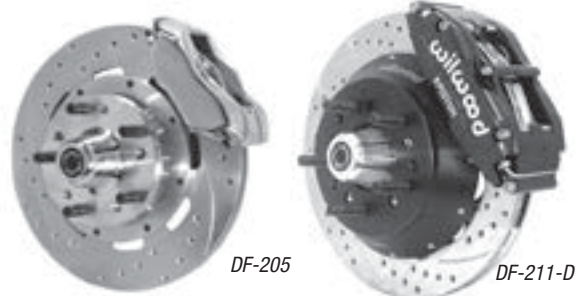

WILWOOD DISC BRAKE KITS

Four piston calipers, 11" rotors, 15" wheels, stock spindles

Wilwood's new limited offset FDL Pro-Series front hub kits for 1964-1974 Chevy II/Novas offer a disc brake upgrade for the original disc and drum spindles. Wheels are only +.19" from original drum brake position, and -.31" from the original disc brake position. This kit provides plenty of clearance inside popular 15" wheels and can be used with either manual or power boost master cylinders. Kits come complete forged billet Dynalite calipers, rotors, hub assembly, brackets and hardware. Requires purchase of additional brake lines.

220-7056 Black anodize calipers, un-drilled rotors . \$764.16

220-7056 Black anodize, drilled & slotted \$879.97

There are many color and finish options available

Six piston calipers, 14" rotors, 18" wheels, stock spindles

The ultimate in big brakes for extreme performance and show with 6 piston calipers and stagger vaned rotors. Use with either manual or power boost master cylinders. Kits come complete with calipers, rotors, hub assembly, brackets and hardware. Requires purchase of additional brake lines.

140-10920 Black anodize calipers, slotted rotors . . . \$2,303.56

220-7056 Black anodize, drilled & slotted rotors . \$2,415.97

Wilwood Discs Brakes For Heidt's Dropped Spindles

DF-205 11" drilled rotors, 4 piston polished calipers & hardware \$895.00

DF-205-D 11" drilled rotors w/ polished hubs, 4 piston polished calipers & hardware . . \$1,050.00

DF-210-D 12" drilled rotors w/ polished hubs, 4 piston polished calipers & hardware . . \$1,075.00

DF-211-D 13" drilled rotors w/ black hubs, 4 piston black calipers & hardware . . . \$1,995.00

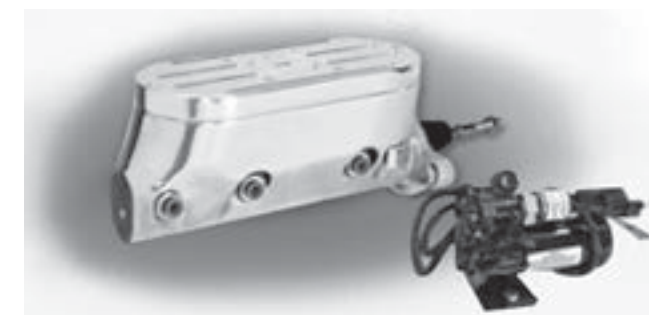

HIGH-POWER ELECTRIC BOOSTER AND MASTER CYLINDER ASSEMBLY

This high pressure system includes an electric remote booster that can be mounted anywhere in the car. This cleans up the firewall, frees up extra valve cover clearance and solves the low vacuum problem that many high performance engines have. Good looking, light weight and easy to install. Features a 1.125" bore, dual circuits and built in metering/proportioning valve. Only 8" x 3.6" x 3.3".

10-56 Electric power brake booster/M.C. \$1,400.00



HEIDT'S POWER BOOSTER & DUAL MASTER CYLINDER

Bolt-on kits for 1967-81 Camaros. *Kits include:* power booster, dual master cylinder and correct proportioning valve for disc-drum or disc-disc cars. Designed for use with our disc brake kits. Fully assembled and plumbed, ready for installation.

DB-110 1967-69 Camaro booster and MC, disc/drum. . \$299.00

DB-110-D 1967-69 Camaro booster and MC, disc/disc . \$299.00

DB111 1967-69 Camaro manual MC, disc/drum. . . . \$175.00

DB111-D 1967-69 Camaro manual MC, disc/disc. . . . \$175.00

DB-118 1970-81 Camaro booster and MC, disc/drum. . \$299.00

DB-118-D 1970-81 Camaro booster and MC, disc/disc. . \$299.00

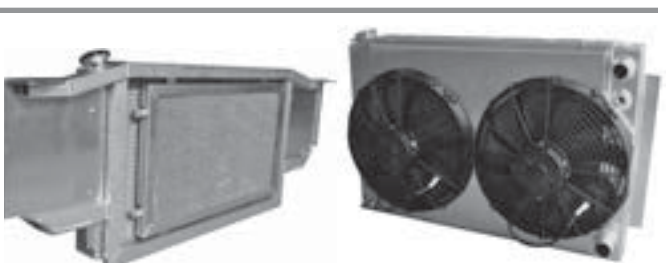

PRC ALUMINUM RADIATORS AND ASSEMBLIES

Beautifully made high-performance aluminum radiators made by Performance Rod & Custom. These custom made radiators are designed to cool big motors in extreme conditions or just cruising around. Just the radiator is available or as a complete assembly with a replacement core support and filler panels. Lots of extras are available such as electric fans, shrouds, A/C condensers and trans coolers. Please call.

2110067 Radiator/core support assembly, basic. . . \$695.00