

Fatman Mustang II sub-frames and suspension

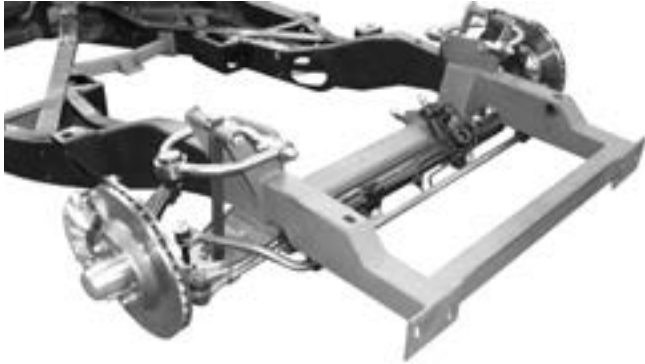

FATMAN MUSTANG II FRONT STUBS

Some cars have a frame design which doesn't allow for a simple Mustang II crossmember installation, yet are too narrow for a GM sub-frame. Fatman builds these weld-on clips which provide a 2-4" drop, and include pre-made mounts for bumpers, radiators and front sheet metal. Stock sheet metal remounts with very minor, or no trimming required. Many applications are available. Please call for details.

1934-59 Buick, 34-56 Olds, 37-58 Pontiac, 34-68 Cadillac, 37-70 Chevy, 64-72 Chevelle, 34-55 Chrysler/DeSoto, 34-56 Dodge/Plymouth, 49-63 Ford, 40-54 Hudson, 49-56 Mercury.

- Stub crossmember only starting at\$1,250.00
- Complete kit with stock springs\$3,450.00
- Complete kit with coil overs\$3,995.00



FATMAN MUSTANG II HUB-TO-HUB KITS

All needed components can be purchased in kit form as shown above. Most kits include coil-over or stock springs and shocks, sway bar, stainless steel tubular control arms, manual rack and pinion, spindles and big brake kits with bearings/seals. Can also be ordered with a Fatman crossmember. Huge selection of crossmembers for everything from Buicks to Willys.

- Crossmember with stock spring package \$2,560.00
- Crossmember with coil-over package \$2,995.00



FATMAN 1949 AND UP DROPPED UPRIGHTS

Many 1949 and up cars have an excellent original IFS that can be modified with dropped uprights and late model brakes. New dropped uprights provide a relatively simple way to lower your car while maintaining proper geometry, alignment and suspension travel. One to three inch drop. Many applications available. Sold by the pair. Please call.

- 1939-54 Chevy, 53-62 Corvette \$395.00
- 1949-53 Ford \$470.00
- 1954-56 Ford, 52-57 Lincoln, Merc. \$450.00
- 1955-57 T-Birds \$535.00
- 1965-73 Mustang and Cougar, 1963-71 Falcon and Fairlane \$580.00
- 1937-56 Buick, 39-56 Olds, 37-57 Pontiac \$395.00

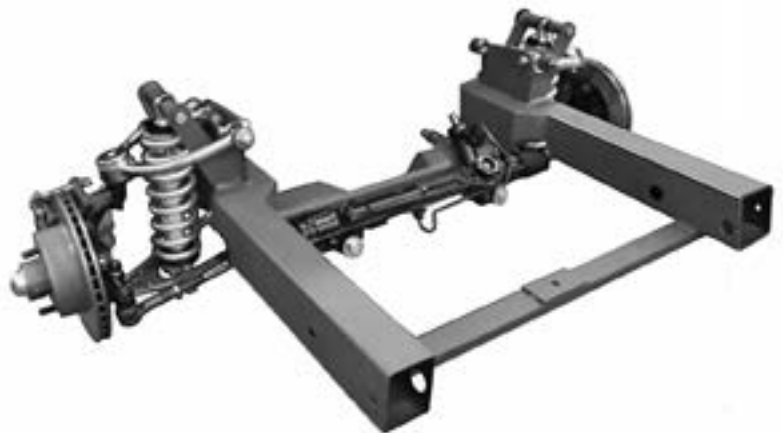

FATMAN 1949-51 FORD/MUSTANG II FRONT STUB

Just weld this complete front clip to your original frame. You'll get a 3"-5" drop with all modern suspension, steering, and brakes. Core support and bumper mounts are built in so sheet metal bolts right back up. Flatheads will not fit. All year Chevy small blocks fit well. Ford engines will need a dual sump oil pan. Both will need the transmission tunnel raised. Mustang II parts and tubular motor mounts are optional.

1949-51 Ford/Mustang II stub frame only from \$1,750.00