

MODEL "A" FRONT CROSSMEMBER

Lowers your '32 chassis 1-1/2". Die formed from 3/16" steel. Also for Model A.

3250 **\$95.00**

NOTE: Center and rear crossmembers are also available.

1928-31 FORD ENGINE AND TRANSMISSION MOUNTS

Kits included weld on frame adapters (frame must be boxed), Chassis Engineering engine side mounts, through bolt cushion set, and instructions.

- CP-2107 Chevy Small Blocks 58-up \$143.00
- CP-2605 Buick V-6 \$143.00
- CP-2205 Ford V-8 \$165.00
- CP-2805 Ford Flathead V-8 \$85.00
- Transmission Mount \$75.00
- C.E. Double K-Crossmember and trans mount \$155.00
- SS-0011 Motor Mount Cushions \$40.00



1932 FORD ENGINE MOUNT KITS

- CP-2107 Chevy Small Blocks 58-up \$143.00
- CP-2607 Buick V-6 \$143.00
- CP-2207 Ford V-8 \$143.00

1933-34 FORD ENGINE MOUNTS KITS

- CP-2104 Chevy Small Blocks 58-up \$143.00
- CP-2604 Buick V-6 \$143.00
- CP-2204 Ford V-8 \$143.00
- CP-2808 Ford Flathead V-8 \$85.55



1932 FORD BOXING PLATES

3/16" thick steel. Front plate extends from front crossmember to beyond firewall. Rear plate covers complete kick-up.

Front or Rear, Pair **\$87.00**

1933-34 FRAME BOXING PLATES

3/16" thick, extends from front crossmember to X-member. Two plates per kit-left and right.

AR-2097 Front pair **\$75.00**

AR-2098 Rear pair **\$75.00**



1932-34 X-MEMBER & TRANSMISSION MOUNTING KIT

Heavy steel formed X-member gives needed rigidity for open or closed cars. Works with most repro or original frames and engine/trans combos. Requires a flat floor pan.

- AT-2032 X-Member \$300.00
- ES-2132 Chevrolet Turbo 350 trans mount. \$105.00

1933-34 CENTER X-MEMBER MODIFICATION AND TRANSMISSION MOUNT KIT

Replaces center part of cross-member. No cutting on X rails. Uses some old rivet holes for line up. Fits all GM transmissions except 400. Can easily be modified for others. Bolt on unit gives 360° strength, a proven concept. Bolts and instructions included.

ES-2130 **\$190.00**



1928-1934 Ford Frame Parts

1928-34 FORD Hot Rod Suspension Parts



1932 SPREADER BARS

Made to exact dimensions of the originals and are a must for setting up your chassis.

3209	Front	\$42.00
3210	Rear	\$53.00
<i>Polished Stainless Steel</i>		
3362	Front	\$90.00
3363	Rear	\$120.00



VINTAGE CHASSIS FORGED I-BEAM & TUBE AXLES

1928-48 Ford 4" drop axle, 47" wide. Uses 1937-48 Ford spindle. State 2" or 2-1/4" perch boss. Forged axles are several times stronger than cast type. Narrower width is ideal for Ford. Requires special main leaf. 1-1/2" narrower between perches.

AU-2107	Forged Axle, 47", 2-1/4" perch	\$375.00
AU-2105	Tube Axle, 46, 47, 48.5", 2" perch	\$375.00



CHASSIS ENGINEERING FORGED SPINDLES

Precision replacement for 1937 to 41 Ford spindle.... **\$250.00**
Complete with king pins fitted

Also Available machined for GM Rotors

Spindle Nuts..... **\$14.75**



KING PIN SETS

3269	1937 to 41 Ford	\$60.95
3279	1942 to 48 Ford	\$60.95

POLYPROPYLENE

Using polypropylene between spring leaves reduces friction and wear, allowing the spring to move freely for a better ride.

AU-2066	1.75"	\$12.00
AU-2067	2.00"	\$14.00
AU-2068	2.25"	\$16.00



FORGED SPINDLE ARMS

Double end on right. For use with dropped axles and cross steering.

1108	1928-34 Ford	pair \$130.00
1108M	Milled for GM brake kit clearance	pair \$140.50

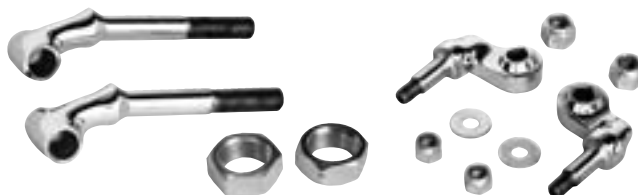

SPRING PERCHES AND LOWER SHOCK MOUNTS

3219P	Deuce Factory stainless perches	\$130.00
3218P	Stainless lower shock mount	\$130.00
Unpolished S.S. perches or lower shock mounts		\$110.00
00000	Perch Jam Nuts	\$120.00

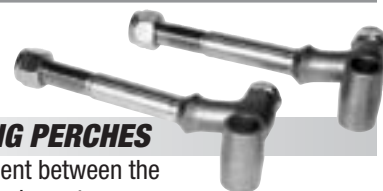

SELF-ALIGNING SPRING PERCHES

Allows for the perfect alignment between the spring and the desired front axle castor.

1928-34 Ford, plain SS	pair \$149.00
1928-34 Ford, polished SS	pair \$199.00



EASY RIDER FRONT SPRING

Chassis Engineering springs feature leaf ends that are rolled thin and diamond cut for traditional Street Rod styling. Special hidden sliders are installed at the end of each leaf and are locked in place so they can't work out. Nothing shows to mar the smooth lines. This is the best appearing and performing early Ford spring available.

FS 2834	\$150.00	
FS2834M	Reversed eye main leaf	\$50.00



FRONT U-BOLTS & SPRING PAD

U-Bolts with lock nuts and spring pads	set \$47.95
Stainless Steel U-bolt and pad set	set \$69.95



SHACKLES

STANDARD

- 3221F Front (specify 1-3/4" or 2") \$45.00
- 3221R Rear 2-1/4" \$45.00

STAINLESS FRONT

- 3355 Polished 1-3/4" \$70.00



FRONT SHOCK KITS

Our tube front shock kits are designed to be functional for the weight of the average Street Rod and to compliment the front end of your car. The kit includes shock absorbers, lower shock mounts, upper frame brackets and all necessary bolts, nuts & washers.

- 3222W Model A and '32 weld-on \$180.00
- 3222B Model A and '32 bolt-on \$190.00
- 3223B 1934 bolt-on \$190.00

Above available with Chrome Shocks and Polished Stainless Lower Shock Mounts \$255.00

- 3300 Tube shocks only pair \$60.00
- 3300A Tube shocks only-chrome pair \$95.00

SHOCK FRAME BRACKETS

Top quality die stamped brackets

- 3324 Model A and 32 Weld-on \$39.00
- 3325 Model A and 32 Bolt-on \$45.00
- 3325A 1934 Bolt-on \$45.00



STEERING U-JOINTS AND SHAFTS

Forged steel with roller bearings make this the best joint available. Specify Vega, Chevy manual, Chevy power, Mustang early, Pinto manual, Pinto power.

- U-joints \$75.00
- Spine or DD shafts \$34.00

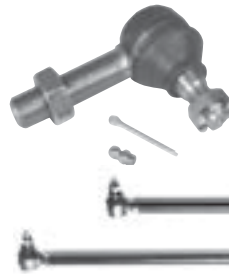

FORD TIE ROD ENDS (with jam nuts)

- 3237R Right hand \$30.00
- 3237L Left hand \$30.00
- Stainless steel tie rod ends ... \$45.00

TIE ROD & DRAG LINK

Made from 7/8" seamless tube with for tie rod end and jam nuts. Made to fit Super Bell Axle or specify center to center length.

- 2180 Tie rod or drag link \$96.00
- Polished S/S tie rod assembly \$212.00



VEGA STEERING ADAPTER

The recommended steering box for 1928 to 34 Fords. The bracket must be welded to a boxed frame.

- 1019 \$45.00
- AU-2131 GM 140 vega steering box \$329.00
- 1020 Pitman arm \$78.95

For complete steering hook-up kits- see page 00



UNI-STEER RACK AND PINION STEERING

Cross Steer was engineered specifically to work with 1928-1934 solid axle Fords and has no bump-steer. It is designed to replace the typical Vega steering box and bolts to the Vega bracket and includes the steering shaft. Also available for new builds w/o shaft.

- 8000460-01 1928-32 new build (no shaft kit) \$450.00
- 8000470-01 1928-32 cross steer retrofit kit (includes shaft kit) \$485.00
- 8000680 1933-34 new build (no shaft kit) \$425.00
- 8000510 1935-40 cross steer retrofit kit \$450.00



1928-1934 Ford Front Suspension Parts

1928-1934 Ford Front Suspension Parts



FRONT 4-BAR or HAIR PIN KITS

Standard Cross Steering

3282C	Model "A"	\$395.00
3282A	1932- 34.....	\$395.00
3282X	Extra Long	\$395.00

Polished Stainless Cross Steering

3282CP	Model "A"	\$595.00
3282AP	1932- 34.....	\$595.00
3282XP	Extra Long	\$605.00



STAINLESS STEEL GT BAT WINGS for 4-BAR SUSPENSION

3299GT	Unpolished.....	pair \$125.00
3299GTP	Polished.....	pair \$155.00

CUSTOM STAINLESS 4-BAR BOLTS

3284	\$95.00
------	-------	---------



STAINLESS 4-BAR ADJUSTERS

3293	Straight 5/8-18 adjuster	each \$25.00
3293B	Straight 3/4-16 adjuster	each \$25.00
3294	11 angled 5/8-18 adjuster	each \$25.00
3295	7 angled 5/8-18 adjuster	each \$25.00

(All part numbers include Jam Nuts) Add \$4.00 for polished

4-BAR BUSHING SLEEVES

For urethane "90" bushings

3259A	Front 4-Bar sleeves.....	each \$4.50
3312A	Rear 4-Bar sleeves	each \$4.99



URETHANE "90" BUSHINGS

3259 B	Front 4-bar urethane 90 bushings.....	\$5.50
3312B	Rear 4-bar urethane 90 bushings	\$6.95

STAINLESS WASHERS

3278A	Front 4-Bar polished 1/2", 9/16" & 5/8" ...	\$3.50
-------	---	--------



SOLID AXLE FRONT SWAY BAR KIT

Completely bolt-on unit mounts to the 4-Bar batwings. Cures many steering and handling problems. Please specify type of axle and bat-wing to 4-bar bolt.

8065	1928-34 Ford front.....	\$175.00
------	-------------------------	----------



1933-34

MUSTANG II INDEPENDENT FRONT SUSPENSION

HEIDT'S MUSTANG II IFS Crossmember Kits retain all factory dimensions and locations, so you get all the benefit of Ford engineering in your front end. The kit includes upper fender brace adapter brackets and radiator mount tabs.

PX101	1933-34 crossmember	\$499.00
#SB3334PM	Front sway bar kit	\$175.00



1937-48 SPINDLE ECI DISC BRAKE KIT

ECI's Disc Brake kits bolt-on to stock or reproduction 1937-48 spindles. Kits include: GM full size car calipers/pads, 11 inch rotors with Ford or GM bolt pattern, bearings/adapters, seals, hardware, brackets and instructions

EC-701CK	GM 4-3/4" bolt circle.....	\$425.00
EC-709CK	Ford 4-1/2" bolt circle.....	\$425.00
EC-730CK	Ford 5-1/2" bolt circle (use F150 rotors). (see page 62 for complete listing)	\$425.00



HEIDTS "SUPER RIDE" INDEPENDENT FRONT SUSPENSION KIT

For Model A, 1932 Ford, & 1933-34 Ford

Independent front suspension gives you twice the ride of a new 4 link dropped axle at a comparable cost. Kit includes main crossmember, dropped spindles, adjustable control arms, Wilwood calipers, 11"

rotors, adjustable coil overs, new rack and pinion steering, stainless adjusters with urethane bushings, OEM style factory ball joints and tie rod ends for durability.

.....\$3,715.00

(Add \$495.00 for stainless control arms)

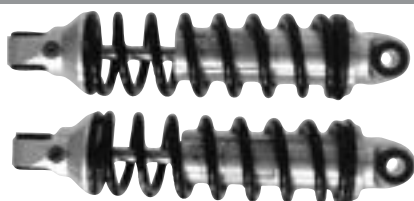

COIL OVER SHOCK ASSEMBLIES -QA1

Coil Over Shocks are available with plain or polished aluminum shock bodies. Spring height adjustment is by a threaded spring seat and locking ring. Shock rate is adjustable using 6 position adjustment knob.

QA1 Coil Over Specifications:

US-304	12-5/8" Extended	9-5/8" Compressed
US-402	14" Extended	10" Compressed
US-404	15" Extended	11" Compressed
US-502	17" Extended	12" Compressed

Spring Rates are available in 150-700# in 50# increments for tuning

US-304	QA1 Coil overs - Ultra-Ride, Front \$449.00
US-402	QA1 Coil overs - Ultra-Ride, Front \$449.00
US-404	QA1 Coil overs - Ultra-Ride, Rear \$449.00
US-502	QA1 Coil overs - Ultra-Ride, Rear \$449.00
	1/2 bearing ends add \$20.00

(Chrome Springs Available)

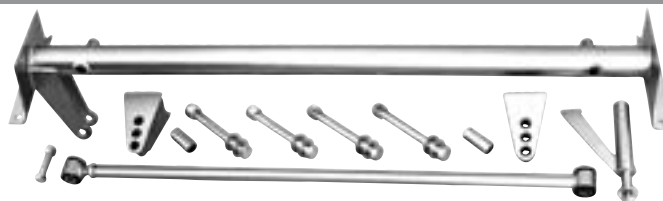

REAR COIL OVER SHOCK SUSPENSION KIT

- Tube crossmember, boxing plates, upper shock mounts
- Panhard bar with axle and frame brackets
- Lower shock mounts with 3 vertical positions to adjust ride height
- Works with Viper coil overs or others

2013	1928-31 Ford \$175.00
3013	1932 Ford \$375.00
4013	1933-34 Ford \$375.00
5013	1935-48 Ford \$375.00



1928-31 REAR UPPER COIL-OVER SHOCK MOUNT

Weld to stock crossmember or replacement tube. Also bolts bumper irons in place.

1090	1928-31 FORD (upper mount) pair \$90.00
------	---------------------------------	---------------



1928-31 REAR 4-BAR KITS

Four high strength steel bars give positive control to the rear end. Threaded adjusters are Stainless with Urethane bushings. Kit comes with frame brackets, 4 bars, axle brackets, bolts and instructions.

2017	1928-31 Ford, has lower coil over mounts built in \$420.00
	Polished S/S add \$200.00

Call 402.886.2275 or click: www.heinzmanstreetrods.com

1928-1934 Ford Suspension Parts

1928-1934 Ford Rear Suspension Parts



PANHARD ROD

Fits C.E. or boxed original frames. Adjustable bar with bolt on rear end bracket. Fits Ford 8" rear ends (Maverick, Mustang, etc.)

2015 \$112.00

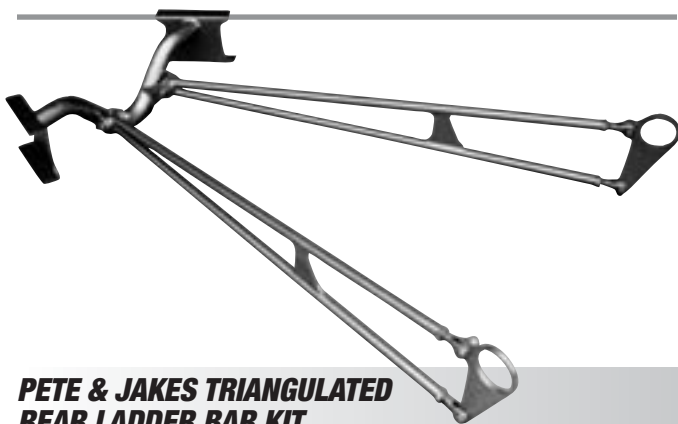

PETE & JAKES TRIANGULATED REAR LADDER BAR KIT

- Mounts rear end into Model A's through 1948 Fords
- Pre-welded crossmember welds to x-member or boxing plates
- Urethane bushings at front center pivot
- Adjustable clevis at rear • Ultimate in strength and traction

(Specify rear axle housing diameter)

2011 1928-'31 Model A \$450.00

3011 1932 Ford \$450.00

4011 1933-'34 Ford \$450.00

DRAG RACING VERSION with double gussets for extra strength

2011 DR 1928-31 Model A \$500.00

3011 DR 1932 Ford \$500.00

4011 DR 1933-34 Ford \$500.00



REAR END MOUNTING KIT

Completely bolt on kit also reinforces rear of frame. No welding on car or rear end required. Uses Maverick or Mustang rear, others fit by moving spring pads. Smooths a normally choppy ride. *Kit includes:* right and left front and rear brackets, shackles, upper shock mounts, lower shock mounts, spring retainers, U bolts, springs, bolts and instructions.

AS-2012 1933-34 \$755.00



REAR TRIANGULATED 4-BAR KIT

The Deuce Factory's rear triangulated 4-bar kit is an ideal way to mount your rear end. The design is very similar to that used by General Motors. All brackets are die stamped in 3/16" steel. The tubing used is 1 by .156" wall and equipped with urethane bushing available in steel or polished stainless steel.

Standard:

2018 Model A \$420.00

3018 1932-34 \$420.00

Polished Stainless/Chrome:

3364P Model A \$550.00

3296P 1932-34 \$550.00



REAR PARALLEL 4-BAR KITS

The Parallel 4-bar kit is very easy to install and is a good choice for many installations. It uses 1 x .156" tube bars with 3/4" stainless adjusters and urethane bushing, chassis mounting brackets, multi-position coil-over axle brackets and hardware. NOTE: These kits require the use of a panhard Rod.

2017 Model A \$425.00

3017 1932 Ford \$425.00

4017RP 1933-34 \$425.00

Chrome, add \$110.00



REAR STABILIZER BAR KIT

Most street rods today are utilizing coil spring suspension which gives a softer ride but will tend to have more roll in the chassis. This anti-roll bar will greatly increase the chassis roll stiffness. The bar is 3/4" dia. and 27" long with 48 splines on the ends of the bar to correspond with the arms. The hole to hole arm length is 8". The bar is mounted to the rear cross member with aluminum pillow blocks and the arms mount to the rear housing with rod end links.

3298 1932-34 \$265.00

8098 1928-34 \$225.00