

**COMPLETE CHASSIS
with IFS Starting at \$6,995.00
exchange**

**1935-40 AND 1941-48
FRAME EXCHANGE
PROGRAM**

**Trade in your original frame for
a ready-to-roll street rod chassis!**

The basic package includes:

- An original 1935-40 or 1941-48 Ford frame sandblasted, repaired and primed
- Overdrive trans X-member modification
- Heidt's Mustang crossmember kit and tubular A-arms
- Mustang II front suspension. Includes: new 5-bolt rotors, shocks, springs, spindles, and a manual rack & pinion steering gear
- Small block Chevy or small block Ford front & rear motor mounts
- 8" Ford rear end-used (9" rear available)
- Chassis Engineering parallel leaf spring rear suspension
- Front and rear sway bars

1935-40/1941-48 exchange \$6,995.00

**Chassis are also available outright
without a frame trade-in Core Charge \$500.00**

**Above chassis with NEW 9" Ford rear, drum brakes
and choice of gear ratios \$ 7,995.00**

1935-40/1941-48 EXCHANGE CHASSIS Options

- a. Heidts Superide II front suspension with coil-overs, tube A-arms, Wilwood disc brakes **\$1,250.00**
- b. Rear 4-bar suspension with coil-overs **\$400.00**
- c. Brake pedal, booster and master cylinder **\$425.00**
- d. GM metric front brake calipers and brackets. **\$185.00**
- e. Wilwood 4 piston front calipers and brackets **\$400.00**
- f. Brake and fuel line package **\$650.00**
- g. Power Steering **\$200.00**
- h. Rear Brake Upgrade
 - Wilwood discs with parking brake **\$400.00**
 - Wilwood discs without parking brake **\$300.00**
- h. Chassis painted/ body work (Du Pont Imron) **\$1150.00**
- k. TRU-TRAC differential upgrade **\$500.00**
- l. Polished stainless steel A-arm package **\$1500.00**

ADDITIONAL OPTIONS

- Narrowed 9" Ford Housing with axles **\$895.00**
- Complete brake-fuel system w/ power booster master cylinder **\$1,050.00**
- Gas tank -poly or coated steel **\$230.00**
- Gas tank-stainless steel **\$950.00**
- EFI In-tank Pump **\$300.00**
- 9" Ford gear case (rebuilt) any ratio **\$1,400.00**



1935-1948 Frame Exchange

1935-1940 Frame and Suspension Parts

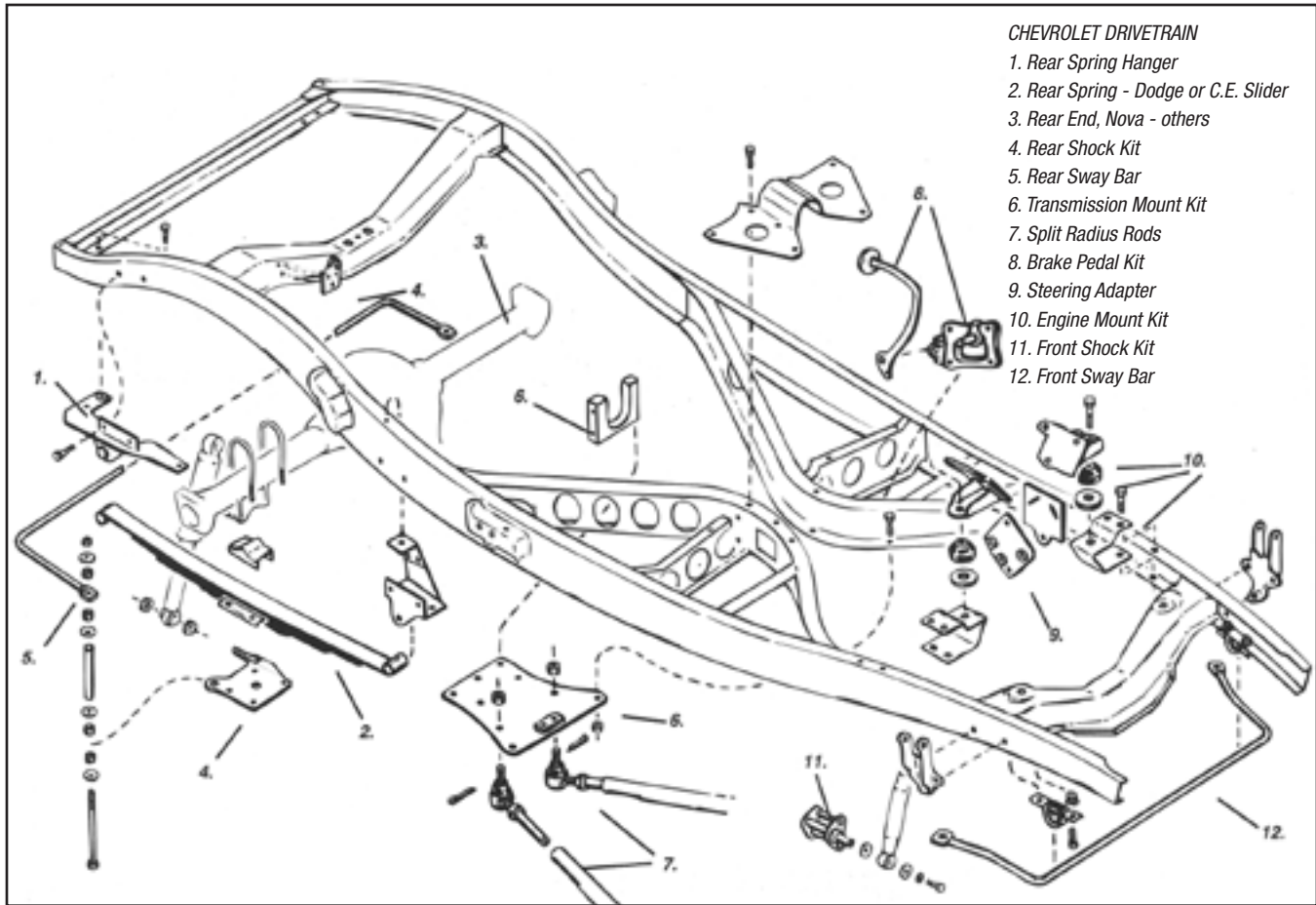

- CHEVROLET DRIVETRAIN**
1. Rear Spring Hanger
 2. Rear Spring - Dodge or C.E. Slider
 3. Rear End, Nova - others
 4. Rear Shock Kit
 5. Rear Sway Bar
 6. Transmission Mount Kit
 7. Split Radius Rods
 8. Brake Pedal Kit
 9. Steering Adapter
 10. Engine Mount Kit
 11. Front Shock Kit
 12. Front Sway Bar

ENGINE MOUNTING KITS

SMALL BLOCK FORD ENGINE MOUNTING KIT-BOLT ON

Includes bolt on frame adapters, frame corner braces, C.E. engine side mounts, thru bolt cushion set, bolts and instructions.

CP-2203 Bolt on kit (solid axle)..... \$165.00

CP-2203PM Bolt on kit (Pinto-Mustang IFS) \$165.00

SMALL BLOCK FORD ENGINE MOUNTING KIT-WELD-ON

Includes weld on frame adapters, C.E. engine side mounts, thru bolt cushion set, bolts and instructions. Frame must be boxed to use. Generally used with Pinto-Mustang IFS.

CP-2203G Weld on kit \$100.00



SMALL BLOCK CHEVY ENGINE MOUNTING KIT

For small block Chevy, includes bolt on frame adapters, C.E. engine side mounts, thru bolt cushion set, bolts & instructions. C.E. mounts eliminate frame cracking caused by the "wedge action" of stock Chevy mounts.

CP-2101 Bolt-in kit \$120.00

CP-2101G Weld-in kit \$105.00

SS-0011 Mount Cushion \$40.00



CENTER X-MEMBER MODIFICATION TRANSMISSION MOUNTING KIT

Uses original side bracing and full 360 degree design for the strongest support possible. Completely bolt on. The only kit that retains X-member strength. Bolts and directions included. For S.B. Chevy, but other engine and transmissions will work. Kits for split wishbones added have mount welded to bottom plate. These come with all parts needed. Fits TURBO 350, Powerglide, Manual 3 and 4 speeds.

ES-2162 1935-36 \$190.00

ES-2163 1935-36 w/wishbone kit. \$250.00

ES-2167 1937-40 \$190.00

ES-2168 1937-40 w/wishbone kit. \$250.00

OVERDRIVE TRANSMISSIONS

For Turbo 700R4. Use with IFS only. For experienced builders.

ES-21650D 1935-36 Overdrive kit. . . . \$499.00

ES-21670D 1937-40 Overdrive kit. . . . \$499.00



Call 402.886.2275 or click: www.heinzmanstreetrods.com

1935-1940 Frame and Suspension Parts



REPLACEMENT X-MEMBER KIT

Formed channel X-member gives excellent rigidity for fiberglass or steel bodies. Ideal for open cars but works well under closed cars too. Fits stock or repro frames. Kits have room for most engine combinations. Will fit under stock bodies but is not an exact stock replacement. X-member is opened up for transmission clearance. The front of the X is angled. Floor pan will bolt down like stock. Two side braces replace stock items, not included with kit. Requires a Chassis Engineering brake pedal. Note: recommended for experienced builders only.

- AT-2036 X-rails \$325.00
- ES2140 Center transmission mount, Chevy 350-etc. \$115.00
- ES-2141 Side braces from frame to Chassis Engineering X-member center. \$70.00



1935-40 BOXING PLATES

Boxing plates are 3/16" thick steel. Two plates per kit, R&L.

- AR-2280 Frt, stock frame, stock crossmember, . . pr \$60.00
- AR-2281 Frt, stock frame, Mustang II crossmember pr \$60.00
- AR-2284 Rear, stock frame pr \$75.00



FRONT CROSSMEMBER

Weld in replacement for the 1935-40 Fords. Clears fuel pump on the Chevrolet V8. For use with CE Easy Rider or original suspension.

- 5024 \$120.00



RADIATOR MOUNTS

State year of car. Use with our crossmembers on stock or repro frames. Stock crossmembers may need slight fitting.

- AU-2250A 1935-39 Std with stock crossmember . . pair \$98.00
- AU-2250B 1935-39 Std with stock crossmember . pair \$98.00
- AU-2250C 1939 DLX-40 with stock crossmember pair \$98.00
- AU-2250D 1939 DLX.-40 with I. F. S. crossmember . . pair \$98.00



WISHBONE SPLITTING KIT

Bolts to X-member to spread wishbone as little as possible. Uses heavy duty 3/4" truck tie rod ends. Must be welded to wishbone. Bolts and instructions included.

- AS-2085 1935-48 \$180.00



BODY MOUNTS

These are replacements for those missing or rusted body mounts on the outside of the 1935-1940 Ford frame (weld on).

- AR-2060 Contains all 4 mounts \$160.00
- Front or rear per pair. \$90.00

BOLT ON BODY MOUNTS

- Front left or right each \$60.00
- Rear left or right each \$60.00



BOLT ON STEERING ADAPTER

This is an excellent change. Mounts GM steering gear, standard or power to 1935-48 Ford. Late column or original may be fitted. Bolts and instructions included.

- AS-2089 1935-36 \$69.00
- AS-2090 1937-40 \$69.00
- AS-2094 1941-48 \$69.00





BOLT ON STEERING ADAPTER with S.B. Ford engine

Intended for use only with engine swap CP-2203. Adapts Saginaw steering boxes, manual or power, to 1935-40 Ford with Ford engine. Late column or original may be fitted. One U-joint required. Bolts and instructions included.

AS-2095 Bolt on steering adapter \$79.00



MASTER CYLINDER ADAPTER

Bolts Mustang master cylinder to 1939-48 Ford (also 1935-38 using 1939-40 brake pedal assembly). Chevy master cylinder can be modified to work. Bolts included.

AS-2021 \$65.00



BRAKE PEDAL KIT

Bolt on brake pedal and mounting kit. Mounts Mustang master cylinder (Chevy cylinder can be modified to work). Bolts and instructions included.

AS-2040 1935-40 \$175.00



POWER BRAKE ADAPTER

Adapts Pinto power booster to stock 1939-1940 or Chassis Engineering pedal assembly. May need X-member alterations for clearance.

AS-2051 for stock 1939-1940 pedal \$90.00

AS-2052 for Chassis Engineering pedal \$90.00



POWER BRAKE BOOSTER- DUAL DIAPHRAGM

This 7 inch dual booster is an ideal size for most street rods

AS-2075 7 inch dual booster \$145.00
8531 8 inch dual booster \$145.00

MASTER CYLINDERS

Please give us details of your application when ordering master cylinders

AU-2036 Mustang 15/16" bore, manual brakes . . . \$79.00
AU-2037S Mustang 1" bore, manual brakes. \$79.00
AU-2037P Corvette 1" bore, power brakes only \$85.00
AU-2039 Corvette 1-1/8" bore, power brakes only \$129.00
AU-2041 Remote Fill 15/16" bore, power brakes only \$79.00
AU-2042 Remote Fill 1" bore, power brakes only . . \$79.00



1937-48 SPINDLE ECI DISC BRAKE KIT

ECI's Disc Brake kits bolt-on to stock or reproduction 1937-48 spindles. Kits include: GM full size car calipers/pads, 11 inch rotors with Ford or GM bolt pattern, bearings/adapters, seals, hardware, brackets and instructions

EC-701CK GM 4-3/4" bolt circle \$425.00
EC-709CK Ford 4-1/2" bolt circle \$425.00
EC-730CK Ford 5-1/2" bolt circle (uses F150 rotors) . \$425.00
 (see page 62 for complete listing)



1935-1940 Brake and Suspension Parts

1935-1940 Front Suspension Parts

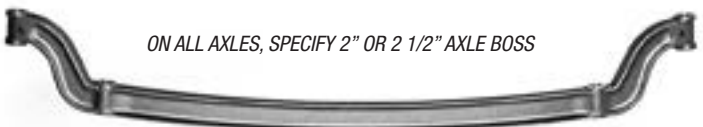

ON ALL AXLES, SPECIFY 2" OR 2 1/2" AXLE BOSS

DROPPED FRONT AXLES

Chassis Engineering forged I-Beam axle is 47" between King Pin centers and is narrower between perch bolts. Requires special main leaf. We recommend this axle when putting a dropped axle in a 1935-40 Ford. Use the 1937-40 wishbone because the 1935-36 is wider and will interfere with the tires when turning.

AU-2107	Vintage I-Beam	\$375.00
	Special main leaf	\$50.00



EASY RIDER FRONT END KITS

All the pieces needed to lower the front end -make it handle and ride super too. This *kit includes* Easy rider spring, (with C.E. sliders, Front shock kit with shackles, Dropped axle, Anti sway bar, New perch bolts, Instructions. A big improvement in driving pleasure. When ordering state engine type and year of wishbone. NEW - Kit now includes forged dropped spindle arms.

FK-35-40	\$1,150.00
-----------------	-------	-------------------



CHASSIS ENGINEERING FORGED SPINDLES

These American made forged spindles fit Ford axles (new or reproduction 1928-48).

1104	1937-41 Ford spindle	\$200.00
1104F-K	Complete with king pins fitted	\$265.00

Also Available machined for GM Rotors

1107	Spindle nuts	\$15.00
-------------	---------------------------	----------------

KING PIN SETS

3269	1937-41 Ford	\$60.95
3279	1942-48 Ford	\$60.95



FRONT SHOCK KIT 1935-40

Super-Strong—3 point mounting on upper bracket insures against breakage. Bolt on kit includes all necessary parts: 2 upper brackets, 2 shock absorbers, 2 combination spring shackles and lower shock mounts and all needed bolts and instructions.

WILL NOT WORK ON 1940 WITH STOCK SWAY BAR.

AR-2037	Front shock kit	\$175.00
----------------	------------------------------	-----------------



PERCH BOLTS

New plain style fits 1935-1948 Ford. Extra long for bolt on lower sway bar mount.

AR-2210	Perch bolts	pair \$43.50
Ar-2212	Perch nut	pair \$7.00



DROPPED STEERING ARMS

Fits 1935-1948 Fords. New C.E. forged arms are pre-bent to fit with dropped axles. Choice of Standard or Milled leg for disk brake adapter clearance. These are a deep drop design to clear 1935-48 wishbones. Bolts go through steering arms and use nuts instead of a blind threads that can loosen or strip.

1108D	\$130.00
Milled for GM brake kit	\$140.00



FS-3540F

NEW 1935-40 STREET ROD SPRINGS

Chassis Engineering slider design uses hidden button sliders. Will not slip out like Teflon strips

	Front main leaf with reversed eyes	\$60.00
FS-3540F	Front, reversed eye spring	\$160.00
RS-3540R	Rear spring for C.E. dual leaf kits	pair \$415.00



RS-3540R



TIE ROD AND DRAG LINK

Ford tie rod ends use right and left hand thread for easy toe adjustment. AR-2180 tie rod has an extra tapered hole on the right to accept a drag link. Measure between the tapered holes and specify the length. Tie rod ends included.

- AR-2180 Drag Link, 36" or less \$100.00
- AR-2183 Tie Rod, more than 36" long. \$110.00



SHACKLES

- 3321F Standard, front, 2" (pr) \$40.00
- AU2214 1935-48 rear end kit (pr) \$60.00



FRONT U-BOLTS SET

Fits 1935-48 front crossmember, stock or reproduction. u-bolts, nuts and bottom plate

- 1000 set \$47.95
- 1000C Chrome. set \$66.95

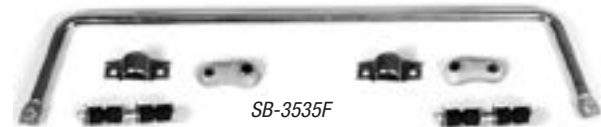

SB-3535F



SB-3535PM



SB-3540R



SB-3540RA



SB-3740F

FRONT AND REAR SWAY BARS

This is an excellent way to improve the handling and overall driveability of the top heavy Ford. Eliminates road sway. For best results use front and rear bars together. All needed linkage and mounting hardware furnished. An ideal addition for any car.

- SB-3536F Front 1935-1936 Also fits 1937-1940 when using early style 1928-1936 axle or C.E. I beam. . . \$175.00
- SB-3740F Front 1937-1940 Fits later axle (perch bolts are farther apart on 1937-1940 axle) \$175.00
- SB-3540FB Front 1935-1940 Use with our 4-bar kit. State type of axle used. (See 4-bar kit). \$175.00
- SB-3540PM Front 1935-1940 Fits Pinto-Mustang IFS kits (also fits many other P-M swaps) \$175.00
- SB-3540R Rear 1935-1940 Fits C.E. rear end kit (can also be adapted to other cars) \$175.00
- SB-3540RA Rear 1935-1940 Axle mounted, fits disc brakes rear like Lincoln Versailles. Very adaptable bar (will work on many other cars). \$185.00



HEIDTS SUPER RIDE II

Give your Fat Fendered Ford a smooth ride, good handling, and the ultimate look with Heidt's Superide II - A complete front suspension kit which includes: main crossmember, dropped spindles, adjustable tubular A-arms, adjustable coil over shocks with chrome springs, 11" disc brake vented rotors, billet calipers or GM calipers, front mounted rack and pinion steering, and factory ball joints & tie rod ends.

OPTIONS AVAILABLE: stainless steel, control arms, power rack and pinion, sway bar, polished shocks and polished calipers.

- 1935-40 Ford car/pick-up. \$3,715.00
- Polished stainless steel package \$1,500.00



HEIDTS MUSTANG II WELD-ON CROSSMEMBER KIT

This kit mounts 1974-78 Mustang II or 74-80 Pinto/Bobcat front suspension to your 1935-40 Ford. Sets the car low and gives a nice ride! Available in Economy and Deluxe versions. Deluxe version has dressed welds Kit includes: lower crossmember, upper spring mounts, boxing plates, rear strut mounts, gussets and instructions (Note: requires extensive welding)

- Crossmember Kit \$450.00
- Crossmember kit complete with all parts \$1,799.00

1935-1940 Front Suspension Parts



BOLT-ON MUSTANG/PINTO I.F.S. FEATURES ADJUSTABLE RIDE HEIGHT

Fully bolt on crossmember uses Pinto or Mustang suspension components. No bump steer or other unpleasant surprises. Upper coil spring pads are adjustable for ride height, giving a 2-1/2" adjustment at the wheel, and excellent method of fine tuning final ride height to your taste. Center support rods add necessary strength to lower strut rod mount. Interlocking tabs between upper pods and crossmember prevent movement.

- IF-3540FP C.E. Mustang II crossmember. \$825.00
- weld-on installation option Add \$90.00
- Complete suspension component package. \$1450.00



1935-40 LEAF SPRING REAR END MOUNTING KITS

Bolt-in kit adds reinforcing to rear of frame. No modifications of any kind to rear end. Uses two 61-69 Dodge pick-up springs. Kit includes front spring mount and rear spring mounts, bolts, general spring information & instructions. This kit uses 74-78 Ford Granada, 57-59 Ford or Ford Maverick rear end. 68-76 Nova rear end also fits but is too wide for many custom wheels. To use with other rear ends, correct spring pads can be welded on.

- AS-2014 1935-36 Car Only \$150.00
- AS-2016 1935-41 Pickup & 1937-40 Car \$145.00
- Complete Kit w/ Springs and all parts required. \$755.00
- AR-2070A Spacer kit w/ spring kit \$50.00
- RS-3540R Rear spring for C.E. dual leaf kits pair \$475.00

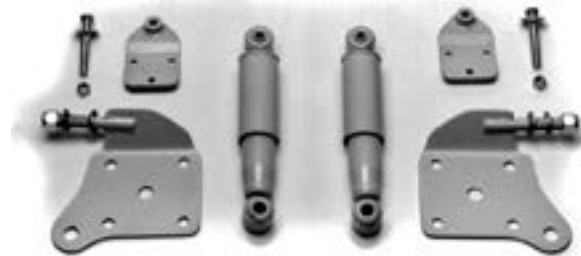

REAR SHOCK KIT

Includes 2 lower spring retainer plates and shock mounts, 2 upper shock mounts, bolts and instructions. Use with our rear end kits only.

- AR-2038A 1935-40 \$200.00

REAR SHOCKS ONLY

- AU-2219 Special valving shock. pair \$73.00
- AU-2219G Gas filled shock. pair \$73.00

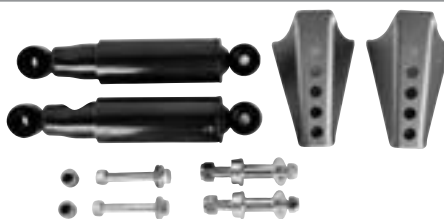

UNIVERSAL REAR SHOCK KIT

- Brackets have 4 vertical positions to dial-in shock travel
- Features Pete & Jakes Rod shocks
- Includes shock studs and upper brackets

- 1070 1935-40 \$115.00
- 1073 1941-48 \$139.00



REAR AXLE SPRING PADS AND LOWERING BLOCKS

Stamped steel replacement axle pads for using when changing spring centers on late rear ends. For 2-1/2" springs.

- AU-2229 Axle Pads \$30.00
- U-Bolts set \$35.00
- AR-2070 Lowering blocks/U-bolt kit. pair \$65.00



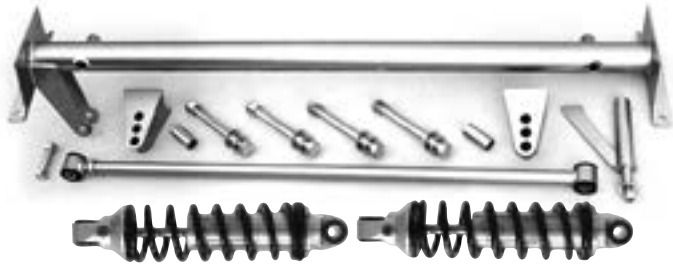

REAR COIL-OVER SUSPENSION KIT

This tube crossmember replaces the stock crossmember using existing rivet holes in the frame for location and easy installation. Includes boxing plates, upper shock mounts and panhard bar brackets welded to crossmember. Lower shock mounts have 3 positions to adjust ride height. Panhard bar axle bracket welds to back side of rear end housing.

5013	1935-40	\$375.00
658	US 404 Coil Overs	\$449.00
US502	QA-1 Coil Overs	\$449.00

(spring rates: 130#, 170#, 200#, 220#, 250#, 300#, 350#)



HEIDTS INDEPENDENT REAR SUSPENSION SYSTEM

The ultimate rear suspension from Heidt's. Uses 9" Ford 3rd member, Wilwood Inboard Brakes, Aldan coil-overs and standard widths from 55" to 62". Several options are available.

Complete hub to hub **\$8,895.00**

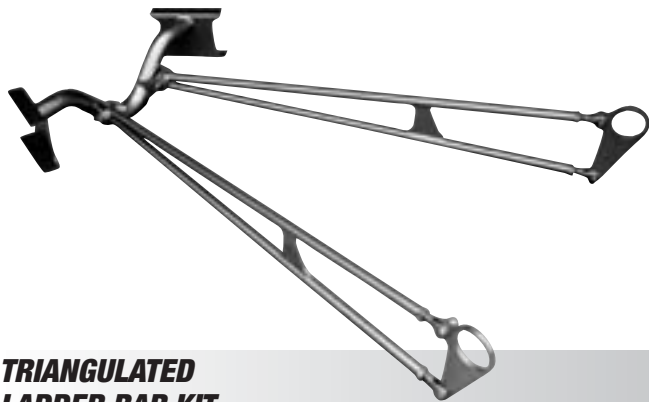

TRIANGULATED LADDER BAR KIT

- Mounts rear end into 1935-40 Ford
 - Pre-welded crossmember assembly welds into stock x-member
 - Urethane bushings at front center pivot
 - Adjustable clevis at rear
 - Ultimate in strength and traction
- (specify housing diameter)

5011	1935-40	\$450.00
5011DR	Drag Race Version.	\$500.00



REAR PARALLEL 4-BAR KITS

The Parallel 4-Bar kit is very easy to install and is a good choice for many installations. It uses 1" x .156 tube bars with 3/4" stainless adjusters and urethane bushing, chassis mounting brackets, multi-position coil-over axle brackets and hardware. NOTE: These kits require the use of a panhard rod.

5017	1935 to 40 Ford: pain	\$425.00
5018	Universal tri-angulated kit	\$425.00
	Chrome	add \$110.00



1935-1940 Rear Suspension Parts